

Optional Mud Valve Installations

Standard options shown on right

Mud Valve: Cast iron or cast 316 stainless steel
 Stem Guide: Ductile iron or cast 316 stainless steel
 Floorstand: Ductile iron (30" or 36") or cast 316 SS (36")
 Pedestal: Ductile iron or cast 316 SS
 Extension Stem: Carbon steel or stainless steel
 Wall Bracket: Ductile iron or cast 316 stainless steel
 Floor Box: Sealed or unsealed, cast iron or cast SS

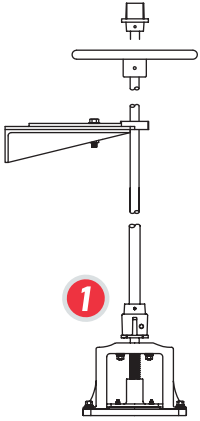

1
Stem Guide
with Handwheel or
2" square nut

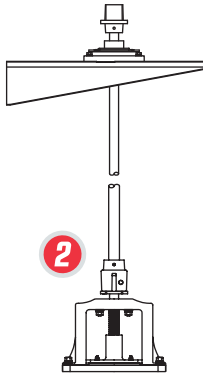

2
Wall Bracket with
Position Indicator

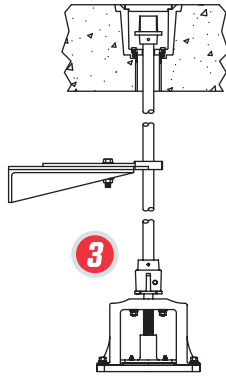

3
Floor Box w/out
Position Indicator

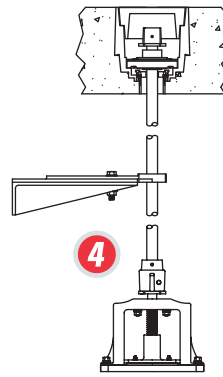

4
Floor Box with
Position Indicator

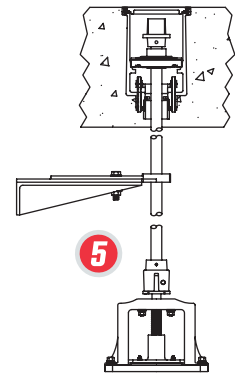

5
Cast Sealed
Floor Box with
Position Indicator

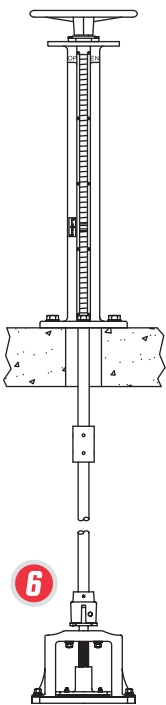

6
Indicating
Floorstand

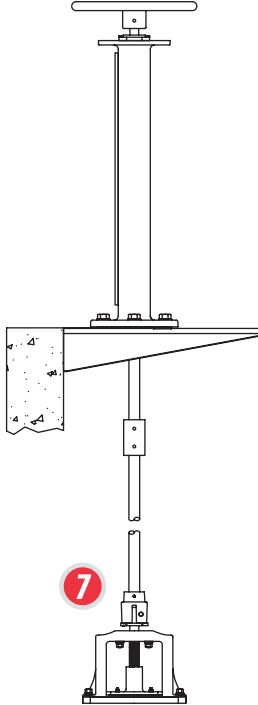

7
Indicating Floorstand
with Wall Bracket*

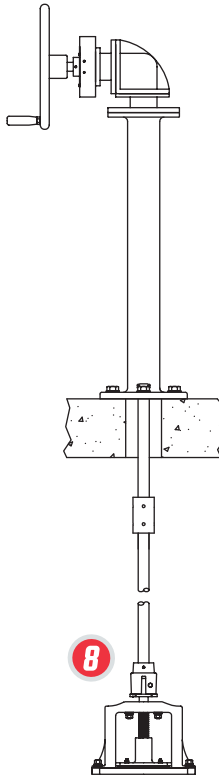

8
Pedestal with Miter Gear,
Crank Handwheel &
Position Indicator
(57T or 275T only)

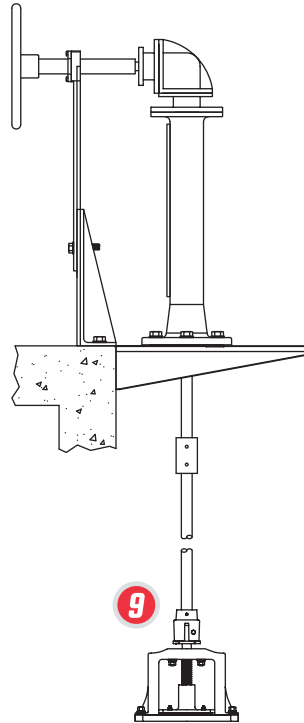

9
Indicating Floorstand with
Wall Bracket, Miter Gear &
Horizontal Extension Stem*

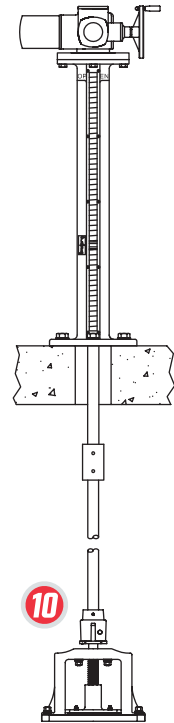

10
Indicating Floorstand
with Actuator

* Indicating slot faces operator and is not visible in installations 7 and 9.