

## Optional Mud Valve Installations

Standard options shown in right

**Mud Valve:** Cast iron or cast 316 stainless steel

**Stem Guide:** Ductile iron or cast 316 stainless steel

**Floorstand:** Ductile iron (30" or 36") or cast 316 SS (36")

**Pedestal:** Ductile iron or cast 316 SS

**Extension Stem:** Carbon steel or stainless steel

**Wall Bracket:** Ductile iron or cast 316 stainless steel

**Floor Box:** Sealed or unsealed, cast iron or cast SS

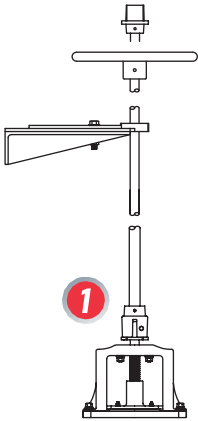

**1**  
Stem Guide  
with Handwheel  
or 2" square nut

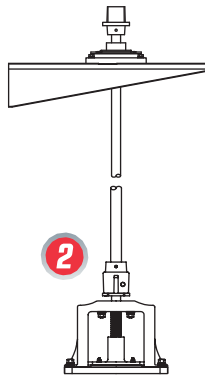

**2**  
Wall Bracket with  
Position Indicator

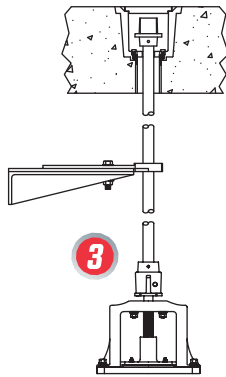

**3**  
Floor Box w/out  
Position Indicator

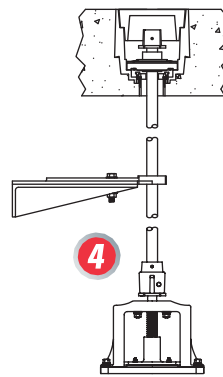

**4**  
Floor Box with  
Position Indicator

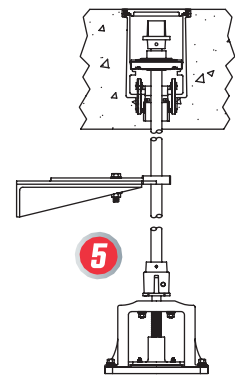

**5**  
Cast Sealed  
Floor Box with  
Position Indicator

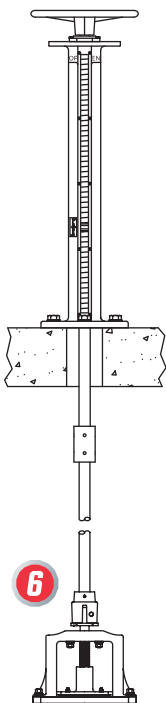

**6**  
Indicating  
Floorstand

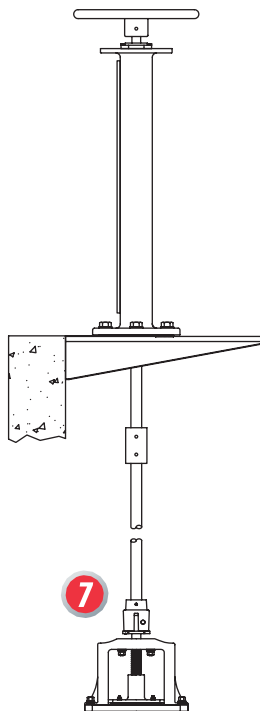

**7**  
Indicating Floorstand  
with Wall Bracket\*

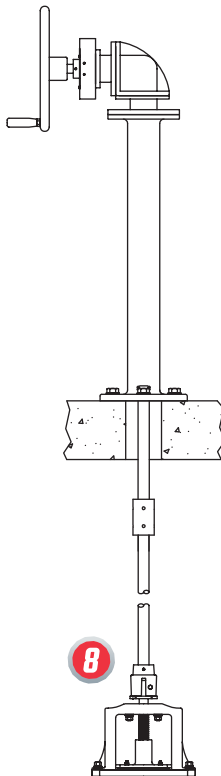

**8**  
Pedestal with Miter Gear,  
Crank Handwheel &  
Position Indicator  
(57T or 275T only)

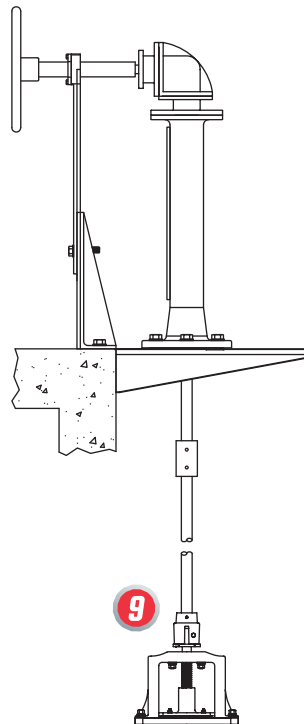

**9**  
Indicating Floorstand with  
Wall Bracket, Miter Gear &  
Horizontal Extension Stem\*

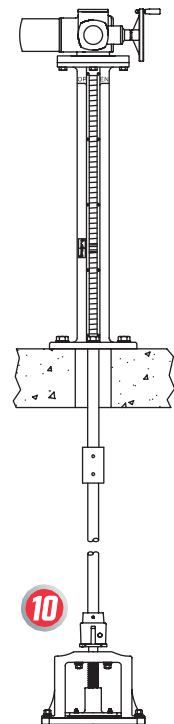

**10**  
Indicating  
Floorstand  
with Actuator

\* Indicating slot faces operator and is not visible in installations 7 and 9.